

1-on-1 Conversations • TV Listening • Listening in the Car • Small Groups and much more

PKT 2.0

Pocketalker® Personal Amplifier



The Pocketalker® 2.0 amplifies sound clearly and easily for better understanding.

Pocketalker® 2.0 Personal Amplifier

Personal Amplifier Model PKT 2.0:

Top

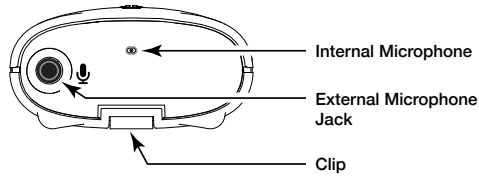

Left

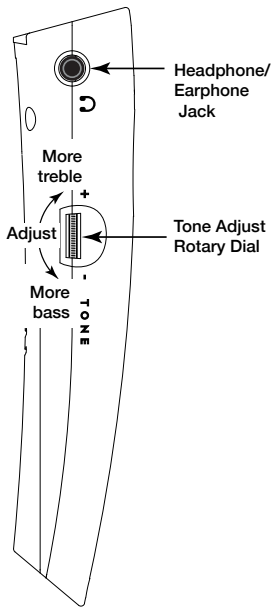

Front

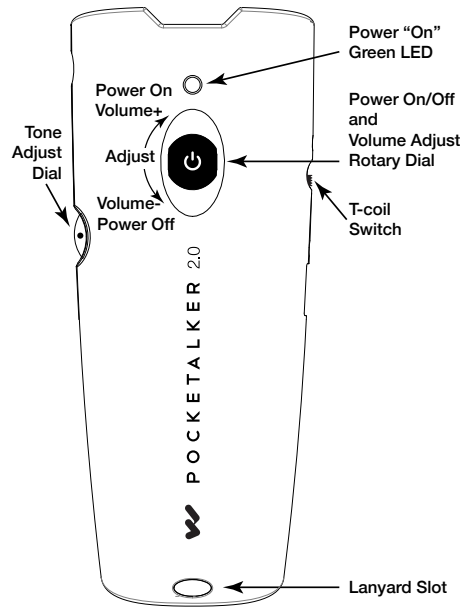

Right

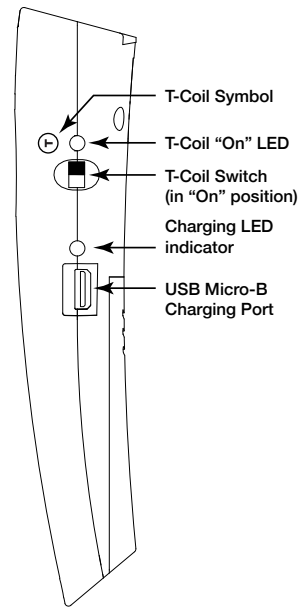

Back

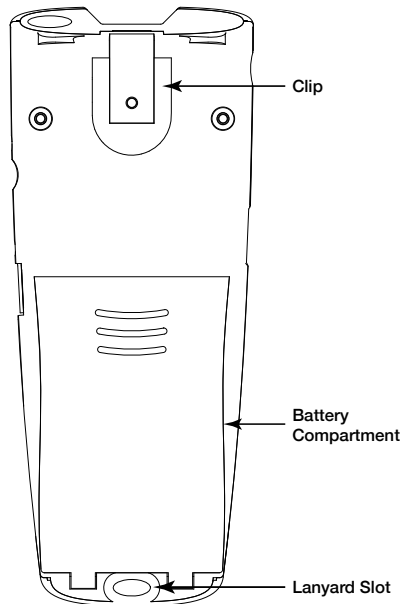

Pocketalker® 2.0 Personal Amplifier

Personal Amplifier Model PKT 2.0:

Dimensions:	4.9" L x 2.0" W x 1.0" H. (124mm x 51mm x 25mm) (Not including clip or microphone assembly)
Weight:	3.1 oz. (88 grams) (with batteries)
Color/material:	White ABS/Polycarbonate molded plastic case.
Battery Type:	Two 1.5V (AAA size), Alkaline or NiMH rechargeable* (Williams Sound BAT 010-2 Alkaline or BAT 022-2 NiMH recommended)
Alkaline batteries:	Battery life: Up to 105 hours (typical usage) with the BAT 010-2. Low Battery Indicator: Power "On" Green light on front panel flashes.
NiMH rechargeable batteries:	**Charging: Up to 16 hours with BAT 022-2. Red LED blinks when charging. Battery life: Up to 80 hours on a full charge End of Charge: Red LED is on solid. At end of charge, maintenance charge is provided. NOTE: Charging requires optional charging kit BAT KT8.
Microphone:	Internal, omnidirectional MEMS microphone (micro-electro-mechanical system). Optional External, omnidirectional, plug-in electret microphone with foam windscreen and 3.5mm mono plug (MIC 014-R).
T-Coil:	Internal with on/off switch and LED indicator.
Tone Control:	External rotary control knob allows user to adjust high/low frequency to optimize hearing.
***Balance Control:	Adjusts Left/Right Volume Balance
Power/Volume Control:	External rotary volume control knob with integrated power ON-OFF switch.
Microphone Jack:	3.5 mm, stereo mini plug. Tip=Mic signal, Ring=NC, Sleeve=Gnd.
Headphone Jack:	3.5 mm, stereo mini plug. Tip=Left/Mono, Ring=Right, Sleeve=Gnd.
Optional Accessories:	Clip: CLP 014; Allows the user to clip MIC 014 to clothing such as a lapel or shirt pocket. Lanyard: RCS 003; Allows user to wear unit around the neck, or as a wrist strap. 3.5mm-3.5mm Extension Cord: WCA 007 WC; extends an external microphone to 12 ft. <i>Stereo</i> Earphones / Headphones / Neckloop: EAR 042 / HED 024, HED 036 / NKL 001-S (stereo) Neckloop <i>Mono</i> Earphones / Headphones / Neckloop***: EAR 013, EAR 008, EAR 022, EAR 041 / HED 021, HED 027 / NKL 001 (mono) Neckloop Charging Kits: BAT KT8 (International)
Approvals:	RoHS, WEEE, FCC, IC, CE
Warranty:	5 years, parts and labor (90 days on accessories)

Electrical Specifications (1 kHz Sine Wave reference) Typical	
Power output:	52 mW (max) into 32 ohms (Stereo)
ALC:	Automatic Level Control; Limits maximum output level
Distortion:	1% THD (max)
Max gain:	63 dB @ 2.5 kHz (Tone=High)

Frequency response

Tone Control at high position:	2.7dB boost at 5 kHz, 6.7dB cut at 400 Hz.
Tone Control at mid position:	0.6dB cut at 5 kHz, 2.9dB cut at 400 Hz.
Tone Control at low position:	2.0dB cut at 5 kHz, 3.0dB boost at 400 Hz.

SPECIFICATIONS ARE SUBJECT TO CHANGE WITHOUT NOTICE.

*Battery switch must be in correct position for battery type being used.

**Charging requires optional charging kit BAT KT8 (International).

***When using mono earphones, headphones or neckloop, the balance control on the Pocketalker must be turned fully counter-clockwise (to the "mono" position) for best volume and battery life.

The Pocketalker is not sold, advertised, or intended for use as a personal hearing aid. Williams Sound recommends that any individual experiencing hearing loss be examined by a physician/audiologist to determine the cause before using an amplification device such as the Pocketalker.

Acoustic Specifications for Headphones recommended for use with the Pocketalker are published on our website.

Note 1: CE approval does not apply if product does not display the CE mark.

Note 2: RoHS2: Directive 2011/65/EU

Note 3: WEEE: Directive 2012/19/EU

This product is covered by the European directives above, including amendments, concerning Waste Electrical and Electronic Equipment (WEEE). Recycle the product and its accessories according to national regulations.

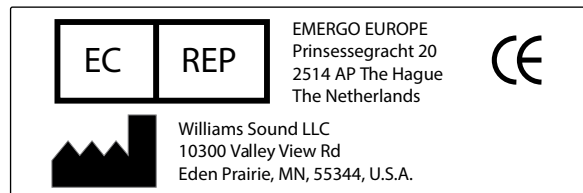

Pocketalker® 2.0 Personal Amplifier

Acoustic Specifications: Typical values in dB SPL (ANSI S3.22-1987)

Lightweight stereo headphone, HED 024: (with 6cc coupler)

Test	Tone High	Tone Mid	Tone Low
SSPL90 (Max)	132.2	132.1	131.9
HF Ave (SSPL90)	124.0	124.0	123.9
HF Ave full on gain (60 dB)	45.2	41.7	38.6
Ref test gain	45.2	41.7	38.6

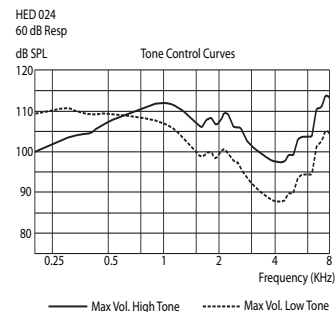
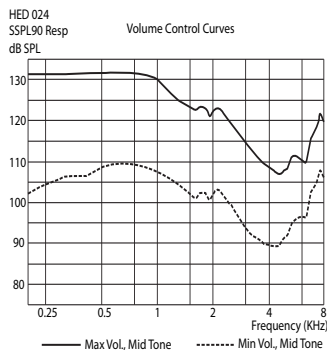

Wide range stereo headphone, HED 036: (with 6cc coupler)

Test	Tone High	Tone Mid	Tone Low
SSPL90 (Max)	128.5	125.7	130.0
HF Ave (SSPL90)	123.4	123.1	124.6
HF Ave full on gain (60 dB)	44.2	40.6	39.3
Ref test gain	44.2	40.6	39.3

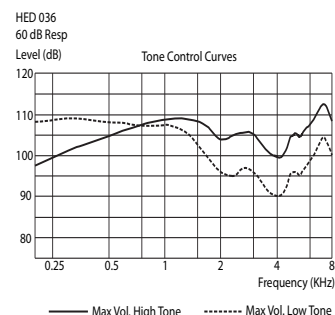
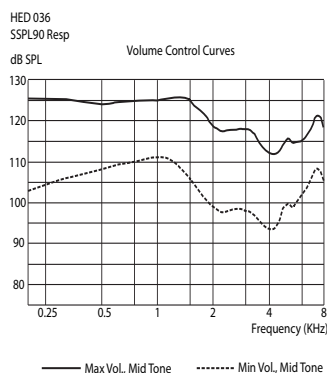

Mini stereo headphone, EAR 042: (with 2cc coupler)

Test	Tone High	Tone Mid	Tone Low
SSPL90 (Max)	124.5	124.5	124.4
HF Ave (SSPL90)	118.9	118.9	118.9
HF Ave full on gain (60 dB)	39.0	35.7	32.8
Ref test gain	39.0	35.7	32.8

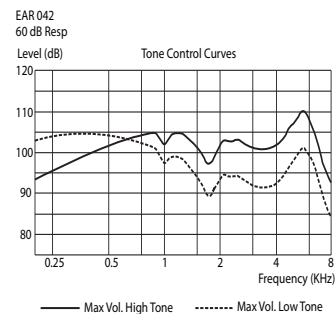
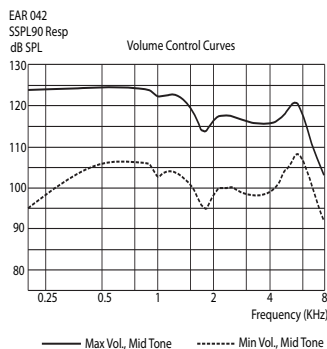

Note: The Pocketalker® 2.0 is not sold, advertised or intended for use as a personal hearing aid. Williams Sound recommends that any individual experiencing hearing loss be examined by a physician/audiologist to determine the cause before using this device.

NOTE: SPECIFICATIONS SUBJECT TO CHANGE WITHOUT NOTICE

Domestic Sales

Williams Sound
10300 Valley View Rd
Eden Prairie, MN 55344
Ph: 800-328-6190 / 952-943-2252
FAX: 952-943-2174
Email: info@williamssound.com

International Sales

International Sales Department
Williams Sound
10300 Valley View Rd
Eden Prairie, MN 55344 USA
Phone: +1 952 943 2252
Fax: +1 952 943 2174
Email: info-intl@williamssound.com



WILLIAMS SOUND®
HELPING PEOPLE HEAR

800.843.3544 / info@williamssound.com / www.williamssound.com